

REFLECTOR LED TIPO TABLETA 200W





MERCURY[®]

HOME & STORE

Especificaciones

Referencia	Potencia	Flujo Luminoso
IRL32	200W	16000 lm



Grado IP	Ángulo de apertura	Color de Luz	Voltaje
IP 65	 120°	 Luz Blanca 6500K	 100-265V
Vida útil	IRC	Factor de Potencia	Protección IK
 30.000 Hrs	 80	F.P. 0.5	IK 05

Descripción

Reflector LED tipo tableta, ideal para parques jardines y lugares comerciales, ideal para zonas que se quieran resaltar y zonas que requieran de una fuente de iluminación de alta potencia.

Temperatura de operación: -20 a 50°C

Dimensiones

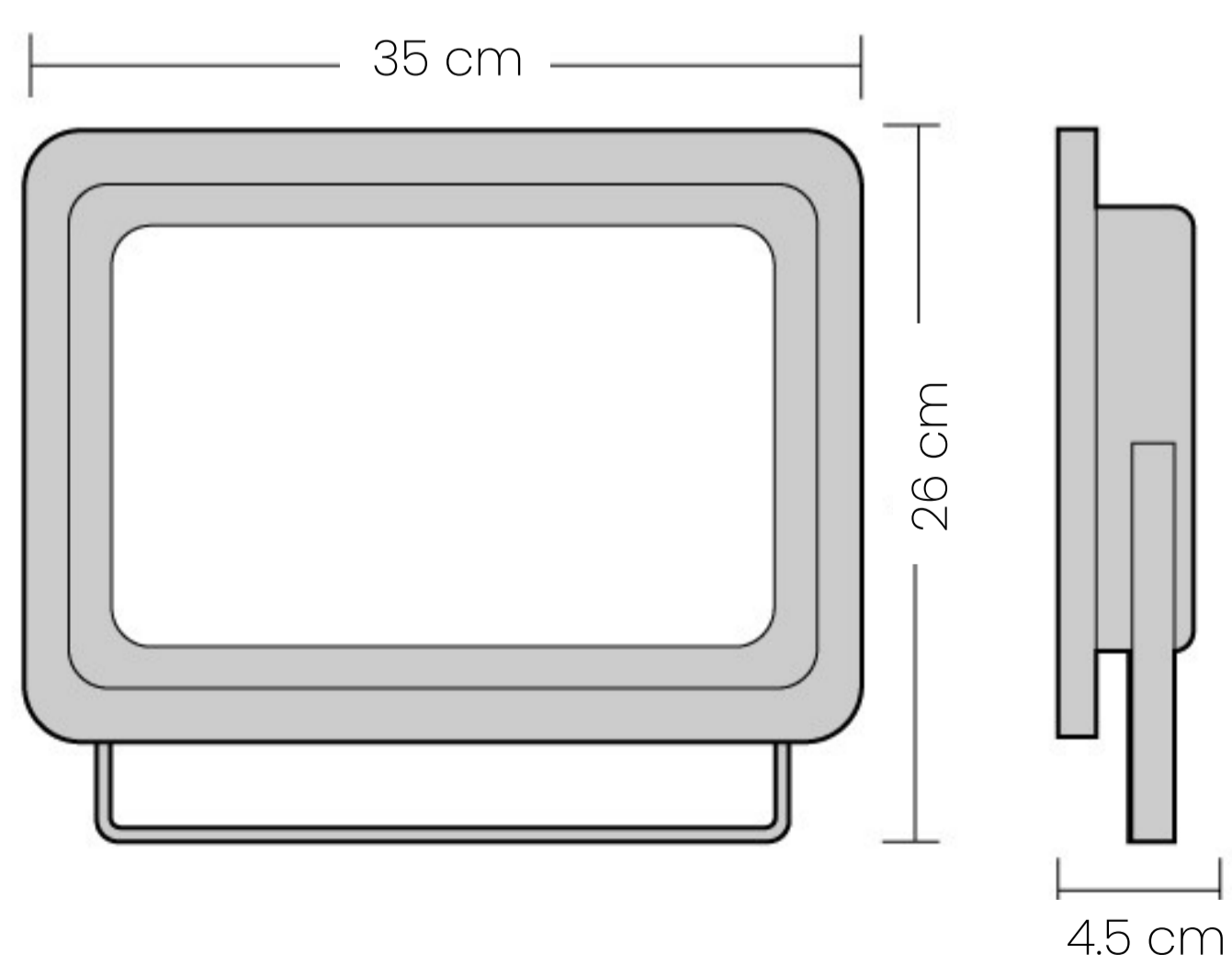

Fotometría

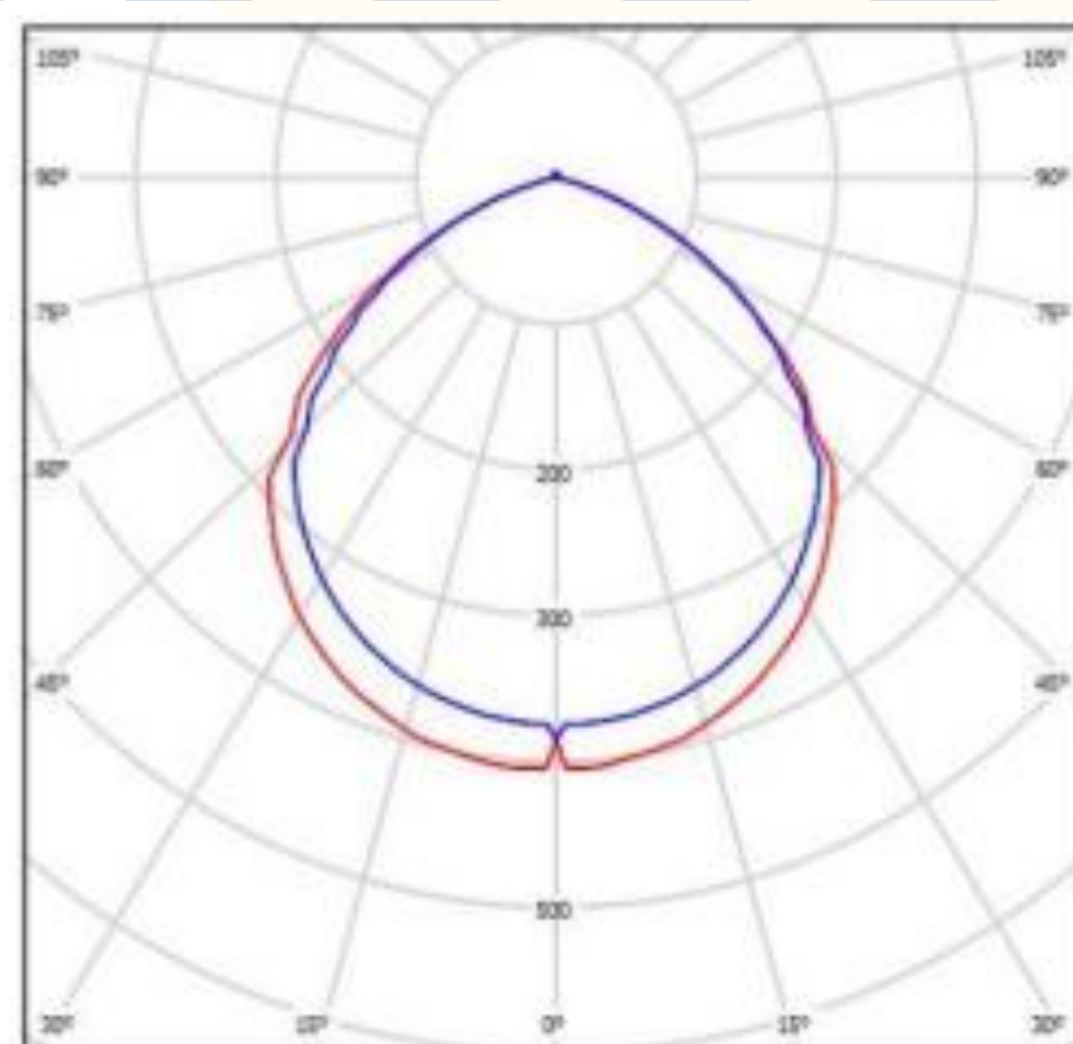

Bogotá, Zona Franca Fontibón
Cra. 106 # 15A-25
Manzana 4, Bodega 2, Lote 35

e-mercury.com.co



[/mercuriyif](https://www.instagram.com/mercuriyif)

HOME & STORE